

PLA-200

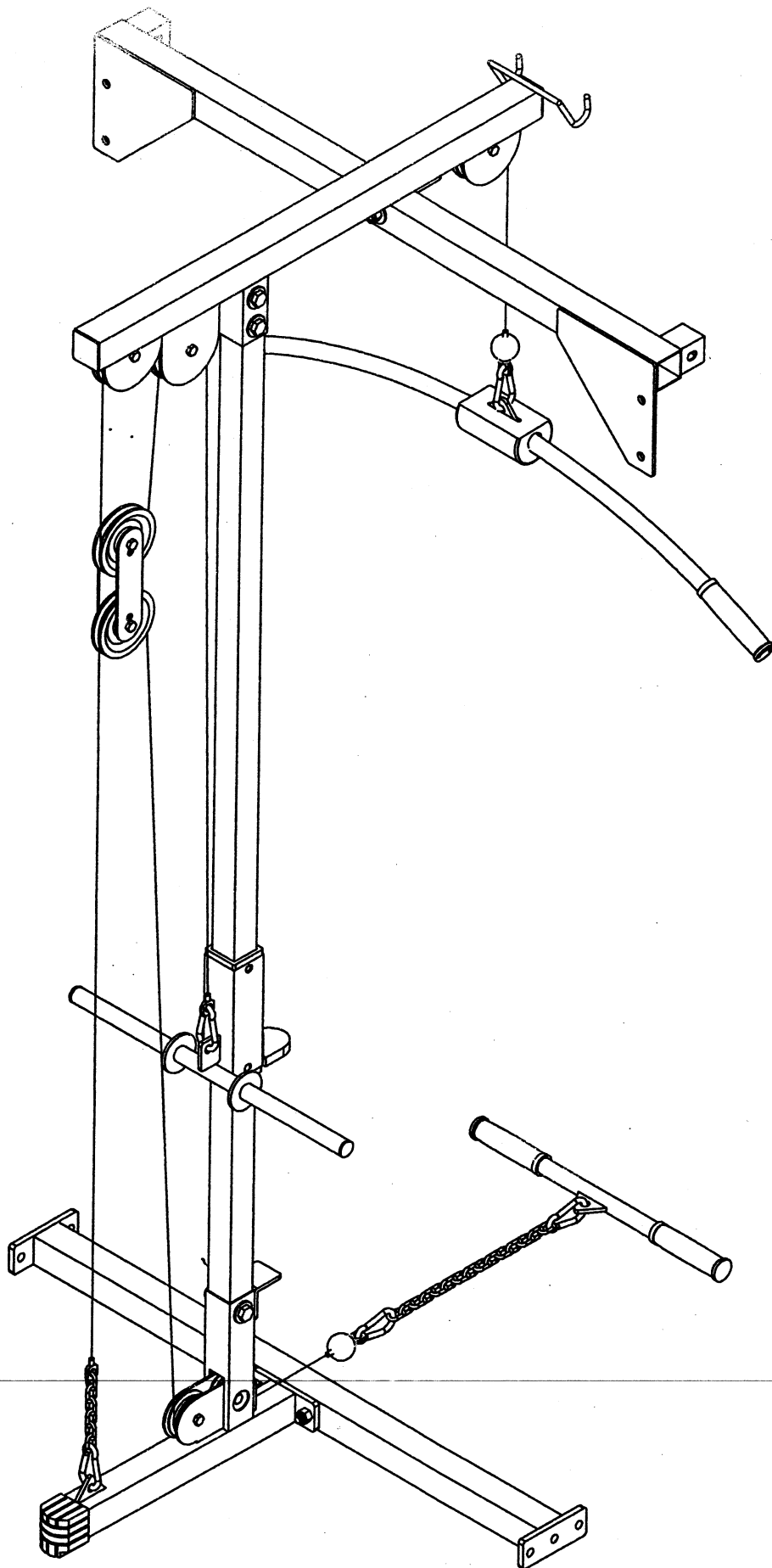

VERSION 0507

HARDWARE ILLUSTRATION SHEET

A1.	M12X80	HEX HEAD BOLT	_____	[2PCS]
A2.	M12X75	HEX HEAD BOLT	_____	[1PCS]
A3.	M12X70	HEX HEAD BOLT	_____	[3PCS]
A4.	M10X40	HEX HEAD BOLT	_____	[7PCS]
A5.	STEEL CHAIN	_____	_____	[1PCS]
B1.	M12	NYLON LOCK NUT	_____	[6PCS]
B2.	M10	NYLON LOCK NUT	_____	[7PCS]
C1.	M12 (I.D)	WASHER	_____	[10PCS]
D1.	Ø110	PULLEY (9213-002)	_____	[5PCS]
D2.	Ø75	PULLEY (9213-006)	_____	[2PCS]
D3.	2"X2"	FOOT CAP (9212-003)	_____	[1PCS]
D4.	2"X2"	END CAP (9211-006)	_____	[2PCS]
D5.	Ø1"	ROUND END CAP (9211-016)	_____	[2PCS]
D6.	60X45	NYLON BUSHING (9211-032)	_____	[2PCS]
D7.	RUBBER GRIP	(9212-016)	_____	[4PCS]
D8.	50X6t	RUBBER DOUNT (9310-019)	_____	[1PCS]
D9.	Ø8	SPRING SNAP LINK (8810-001)	_____	[4PCS]
D10.	STEEL CABLE	_____	_____	[1PCS]
D11.	STEEL CABLE+CHAIN	_____	_____	[1PCS]
D12.	Ø6	SPRING SNAP LINK (8810-002)	_____	[1PCS]

Qty.

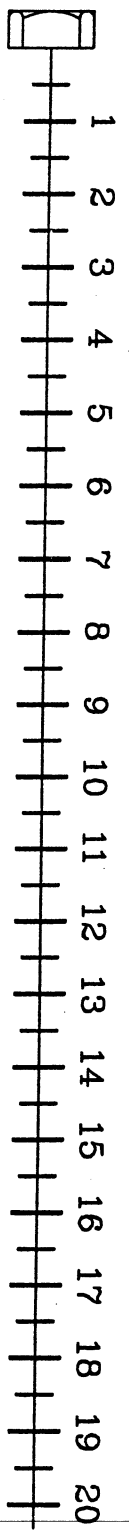
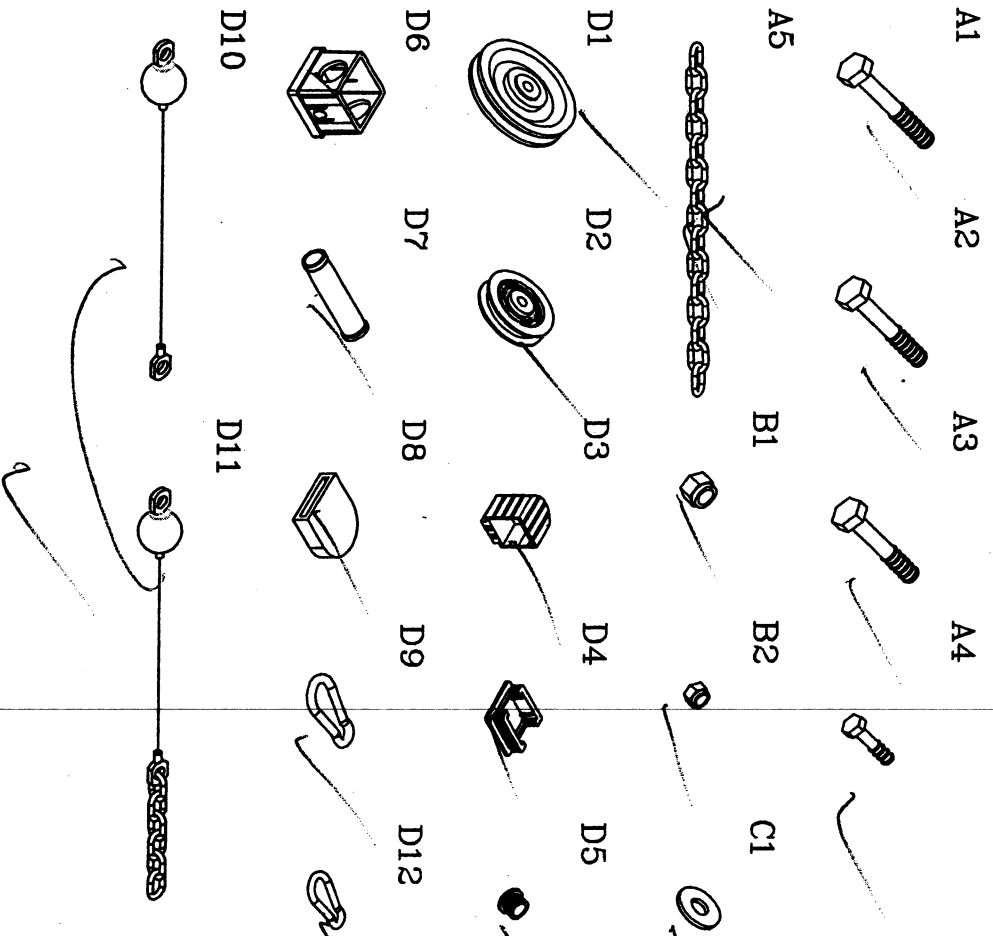

PLA-200 PARTS ILLUSTRATION SHEET

A [1PCS]

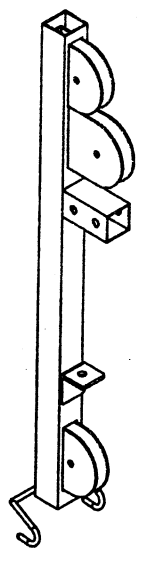

D [1PCS]

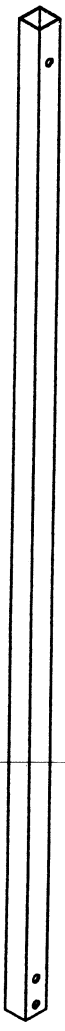

B [1PCS]

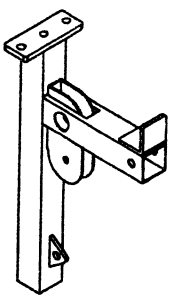

E [1PCS]

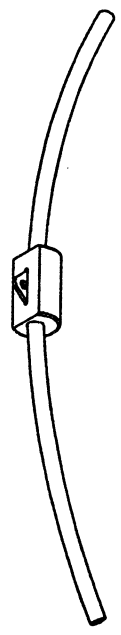

C [1PCS]

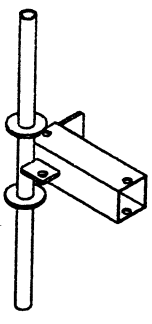

F [1PCS]



G [2PCS]
8342-014



